



MARK ROBERTS MOTION CONTROL

TRIGGER BOX



QUICK START GUIDE

QSG Product Code: MPMC-1282-01

Product Covered: MPMC-1066-00

Trigger Box Quick Start Guide

QSG Product Code: MRMC-1282-01

Product Covered: MRMC-1066-00

Modification Date: 8 March 2022

© 2016 Mark Roberts Motion Control Ltd. All rights reserved.

No part of this publication may be reproduced, transmitted, or translated by any means — graphical, electronic, or mechanical — including photocopying, recording, taping, or storage in an information retrieval system, without the express written permission of Mark Roberts Motion Control.

Although every care has been taken to ensure that the information in this document is accurate and up to date, Mark Roberts Motion Control continuously strives to improve their products and may make changes to the hardware, firmware, and software described in this document. Mark Roberts Motion Control therefore cannot be held responsible for any error or omission in this document.

All product names mentioned herein are the trademarks or registered trademarks of their respective owners.

Contact information	
Mark Roberts Motion Control Ltd.	
Unit 3, South East Studios	
Blindley Heath	
Surrey	
RH7 6JP	
United Kingdom	
Telephone:	+44 (0) 1342 838000
E-mail:	info@mrmoco.com (sales and general enquiries) support@mrmoco.com (customer support)
Web:	www.mrmoco.com www.mrmocorentals.com

Contents

Chapter 1	Quick start	1
	Safety.....	1
	Overview	1
	Connecting the cables	2
	Configuration A	3
	Configuration B.....	3
	Configuration C.....	3
	Trigger Box control summary	4
	Using the trigger outputs	5
	Testing the trigger outputs.....	6
	Using the trigger inputs.....	7
	Testing the trigger inputs	7
	Using the Camera On/Off trigger output	8
	Using the Sync input from a camera	10
	Testing the Sync input and Camera On/Off trigger output.....	12
	Sync and camera controls	12
	Testing the Sync signal input only	14
	Testing the Sync signal input and External Camera trigger output together	15
	Returning the Trigger Box to normal working mode.....	17
Appendix 1	Troubleshooting.....	18
	Typical symptoms, causes, and actions	18
Appendix 2	Trigger Box panels	22
	Panel and connector summary.....	22
	Connector pin-out information.....	24
	Triggers connector.....	24
Appendix 3	Laser Switch	26
	Connecting the Laser Switch.....	26
Appendix 4	Specifications.....	29
	Circuit diagram	30

Chapter 1 Quick start

Safety

- Do not use around flammable gas. All electrical equipment can generate sparks that can ignite flammable gas.
- Keep the equipment dry. The system has **not** been made weatherproof. Do not use with wet hands.
- Keep cables tidy. Use cable ties to keep them out of harm's way. If you have a head with slip rings then make use of them; avoid running any cables between the base and the rotating head or camera.

Overview

Thank you for using the Trigger Box from Mark Roberts Motion Control (MRMC). You use the Trigger Box to send and receive trigger and synchronisation signals between external devices and an RT-14 interface box. The RT-14 unit itself is, in turn, attached to the motion controlled robotic camera rig and a Windows computer running Flair Motion Control Software. You can also use an RT-14 interface box instead of an RT-14, as these units have similar connectors and features.

The Trigger Box has the following main features:

- Five trigger outputs that you can activate from Flair, either manually or by pre-programmed camera moves.
- Three trigger inputs that you can use to activate events in Flair, such as playing a pre-recorded camera move.
- Synchronisation (sync) input for receiving a sync signal from a video camera and passing it on to Flair and the rig.
- Camera trigger on/off output, for triggering a camera on and off from Flair.
- Built-in facilities for generating and checking input and output signals to test components of the system, without needing to connect all of the system.

The Trigger Box is a robust unit designed for day-in, day-out use in a professional studio environment.

Connecting the cables

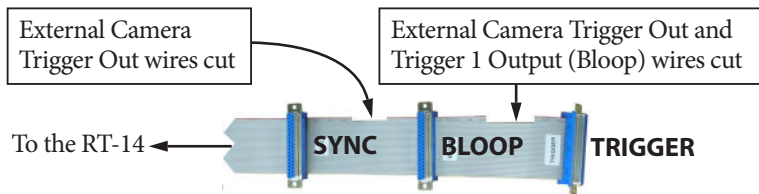

The ribbon cable supplied with the Trigger Box has specially cut wires that give the **SYNC**, **BLOOP**, and **TRIGGER** connectors different capabilities. This allows three possible connection configurations:

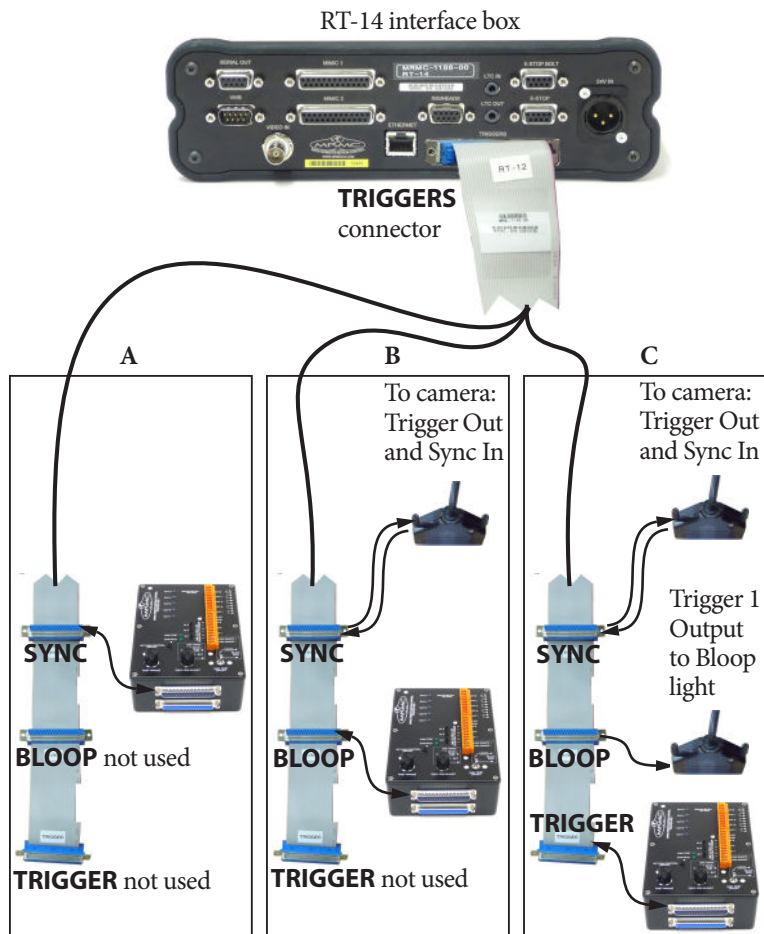

Configuration A

The External Camera Trigger Out, Sync In, and all other triggers are going through the Trigger Box.

Configuration B

The External Camera Trigger Out and Sync In are directly connected to the camera.

The other trigger signals are going through the Trigger Box.

The External Camera Trigger Out signal wires to the **BLOOP** connector are cut on the ribbon cable, so the Camera Trigger Out signal cannot reach the Trigger Box in this configuration.

Configuration C

The External Camera Trigger Out and Sync In are directly connected to the camera.

The Bloop light also has a direct connection. The Bloop light plug itself (black in the photograph) is wired for two inputs:

- If you plug the Bloop light into the **BLOOP** connector on the ribbon cable, you can trigger it with the Trigger 1 Output signal.
- If you plug the Bloop light into the **SYNC** connector on the ribbon cable, you can trigger it with either the Trigger 1 Out or Camera Trigger Out signal, and thus use it to test the External Camera Trigger Out.

The External Camera Trigger Out and Trigger 1 Output (Bloop) signal wires to the **TRIGGER** connector are cut on the ribbon cable, so neither of these signals can reach the Trigger Box in this configuration.

Note

In all cable configurations, the Sync signal that can be produced by the internal simulated camera in the Trigger Box can reach the RT-14 unit and Flair. When you are shooting make sure the Trigger Box is not generating a test Sync signal which will interfere with the real Sync signal coming from the camera. That is, make sure the **INT CAM CONTROL ON/OFF** and the **CAM TEST ON/OFF** switches on the Trigger Box are **Off**. See *Sync and camera controls* on page 12.

To connect the Trigger Box to your external devices you connect wires to the terminals in **pairs**. For example:

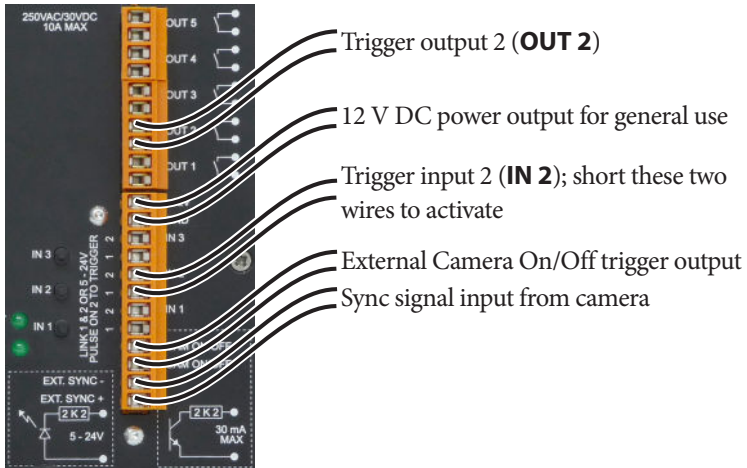

Trigger Box control summary

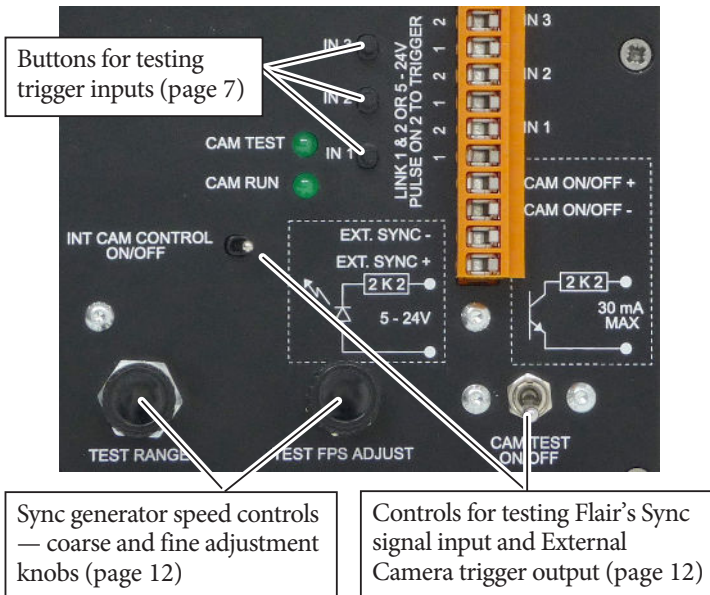

Using the trigger outputs

Each trigger output consists of a pair of connectors, a corresponding LED on the panel, and an internal relay. When a trigger is activated from Flair software, the relay for that pair closes, completing the external circuit and triggering the external device. The corresponding LED (also numbered **OUT 1** to **OUT 5**) is lit during activation.

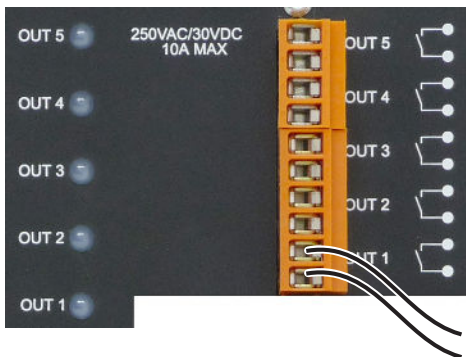

Hint

The LED is powered by the circuit that closes the relay — not by the external circuit that is completed when the relay closes. Therefore a lit LED only indicates that Flair has activated the trigger; it is **not** a check to see if the external circuit now has current flowing through it.

Trigger Output 1 (Bloop) is a special case due to the way the ribbon cable is cut (see page 2). The Trigger 1 Output signal will only reach the Trigger Box if the Trigger Box is plugged into the **SYNC** or **BLOOP** connectors.

The external device that is being triggered must provide its own power for the trigger circuit, up to 250 Volts AC or 30 volts DC, 10A maximum; **for highly inductive loads current should be limited to 3A**. Contact MRMC for further advice on maximum current for triggering external devices.

In Flair, the button for trigger **OUT 1** is labelled **Bloop** by default unless you have changed it, as it is usually used to trigger the Bloop light. The other buttons in Flair use label numbers that match the trigger outputs on the Trigger Box; that is, Flair button **Trigger 2** corresponds to **OUT 2**, button **Trigger 3** corresponds to **OUT 3**, etc. Again, you can change these names in Flair by using the same menu options that you use to add triggers to a move: **Setups > Outputs > #1 - Bloop, #2, #3**, etc. See the Flair documentation for details.

Testing the trigger outputs

You can test that the Trigger Box is receiving trigger signals from Flair, without needing to attach anything to the **OUT** connectors on the Trigger Box:

1. In Flair, use menu option **Setups > Outputs > Test Outputs**.
2. In the pop-up, click on one of the **Trig** buttons.

When you press the button, the corresponding numbered **OUT** LED should light up in on the Trigger Box panel. For example pressing **Trig 3** makes the **OUT 3** LED light up.

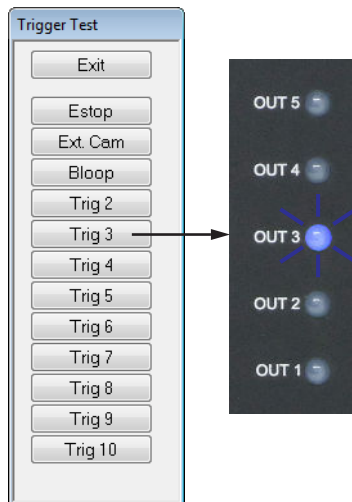

Hint

Trigger Output 1 (Bloop) is a special case due to the way in which the ribbon cable is cut (see page 2). The Trigger 1 Output signal will only reach the Trigger Box if the Trigger Box is plugged into the **SYNC** or **BLOOP** connectors. The **OUT 1** LED will not light if you have attached the Trigger Box to the **TRIGGER** connector on the RT-14 ribbon cable, although in this case the Bloop light that you have attached to the **BLOOP** connector on the same ribbon cable should light up.

To test the External Camera (**Ext. Cam**) trigger output, see *Testing the Sync input and Camera On/Off trigger output* on page 12.

Using the trigger inputs

You can wire the trigger inputs to the Trigger Box in two different ways, shown in the following example for trigger input 2 (**IN 2**):

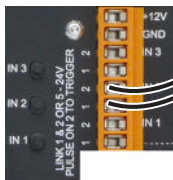

Trigger input 2 (**IN 2**) wires connected to **1** and **2**. To activate the trigger, short these two wires.

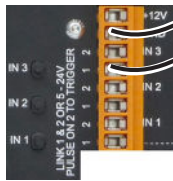

Alternative wiring for all trigger inputs (**IN 3** in the diagram example). Attach your ground wire to **GND** instead. To activate the trigger, apply 5 to 24 Volts DC to connector **1**.

To set up Flair to initiate an action when it receives a trigger input you use the menu option **Setups > Inputs Setup**. See the Flair documentation for details.

Testing the trigger inputs

You can test that the Flair software is correctly receiving trigger input signals from the Trigger Box, without needing to connect anything to the **IN** connectors on the Trigger Box:

1. In Flair, use menu option **Setups > Inputs Setup**.
2. Press one of the numbered **IN** buttons on the Trigger Box panel.

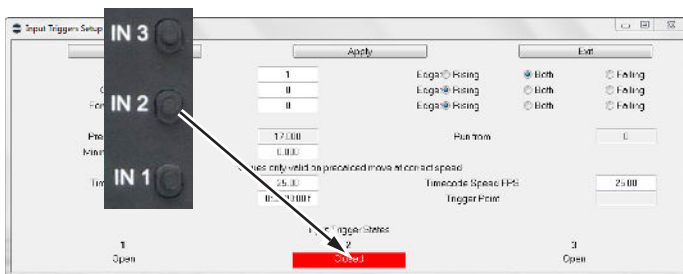

The corresponding numbered **Input Trigger State** in the pop-up should change from **Open** to **Closed**.

Using the Camera On/Off trigger output

The **CAM ON/OFF** trigger output on the Trigger Box consists of a pair of connectors with an internal relay. When the External Camera (**Ext. Cam**) trigger is activated from Flair software, the relay for this pair closes, completing the external circuit and triggering the camera.

The camera that is being triggered must provide its own power for the trigger circuit, up to 250 Volts AC or 30 volts DC, 30 milliamps maximum current. The internal resistance for this circuit is 2.2 kilo-ohms.

In order for the Camera On/Off Trigger output to reach the camera via the Trigger Box's **CAM ON/OFF** connectors, two other conditions must be met:

- The Trigger Box must be plugged into the **SYNC** connector on the ribbon cable. The Camera Trigger Output wires do not reach the **BLOOP** or **TRIGGER** ribbon cable connectors — see *Connecting the cables* on page 2.
- The **CAM TEST ON/OFF** switch must be **Off**. This routes the Camera Trigger output to the connectors instead of to the Trigger Box's internal simulated camera (Sync generator).

You can test the Camera On/Off trigger output at the same time that you test the Sync signal. See *Testing the Sync input and Camera On/Off trigger output* on page 12.

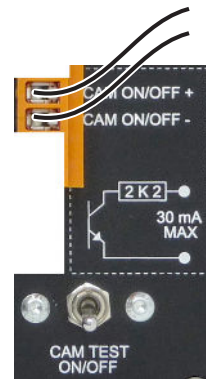

Notes

Using the Sync input from a camera

Flair can use the Synchronisation (Sync) signal from a video camera to control the speed at which the rig moves during a scene. For details of doing this refer to the Flair documentation.

There are two typical ways to get the Sync signal from the camera into the RT-14 interface box (and from there into Flair):

- Plug the External Camera Trigger Out/Sync In cable into the **SYNC** connector on the ribbon cable (see page 2).
- Connect the Sync In signal wires to the Trigger Box (see below).

Hint

The wires for the Sync In signal are not cut on the ribbon cable, so you can put the Sync In signal into any plug or device on the cable.

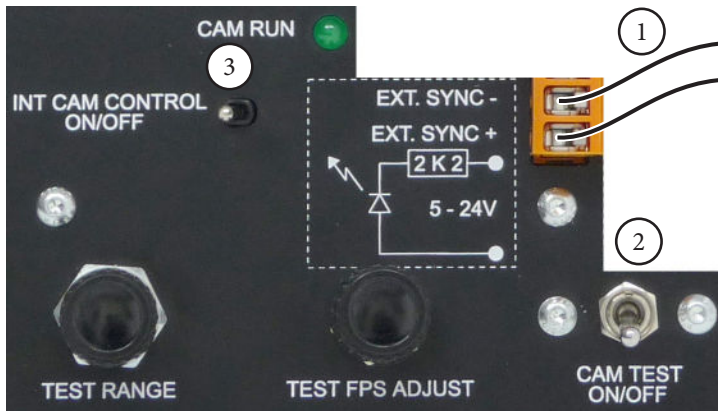

1. Attach the Sync wires from the camera to the pair of **EXT. SYNC** connectors on Trigger Box.

The Sync signal coming from the camera must be 5 to 24 Volts DC. The internal resistance of this circuit is 2.2 kilo-ohms.

2. Make sure the **CAM TEST ON/OFF** switch is Off. This position reads the incoming Sync signal from the connectors and sends it on

to Flair, instead of sending the Sync signal that can be generated by the Trigger Box's own internal simulated camera.

3. Make sure the **INT CAM CONTROL ON/OFF** switch is **Off** (**CAM RUN** LED is unlit). This ensures that the internal simulated camera (Sync generator) in the Trigger Box is off, so that it cannot interfere with the real Sync signal coming from the camera.
4. In Flair, use the menu option **Setups > External Camera Setup** to configure how Flair uses the Sync signal in the software. For details refer to the Flair documentation.

Testing the Sync input and Camera On/Off trigger output

The Trigger Box has a built-in simulated camera (Sync signal generator) which you can use to test that the Flair software can correctly receive a synchronisation (Sync) signal, via the RT-14 unit, without needing to attach a real camera to the system.

You can turn the Sync signal generator on or off from either the Trigger Box or from Flair. If you do it from Flair, this also tests the External Camera On/Off trigger facility in Flair, as this is what you use to trigger the simulated camera (Sync generator) in the Trigger Box.

To test the Sync input, the Trigger Box can be plugged into any connector on the ribbon cable. To test Sync input and Camera On/Off trigger together, the Trigger Box must be plugged into the **SYNC** connector on the ribbon cable.

Sync and camera controls

The next diagram shows the controls for generating a simulated Sync signal and sending it to Flair, and using the External Camera trigger in Flair to activate that signal.

Hint

In the **connector** labels on the Trigger Box, the word “**CAM**” refers to the real camera whose trigger wires you attach to the Trigger Box. In the **switch and LED** labels on the Trigger Box, the word “**CAM**” refers to the internal simulated “camera” in the Trigger Box that is generating the test Sync signal.

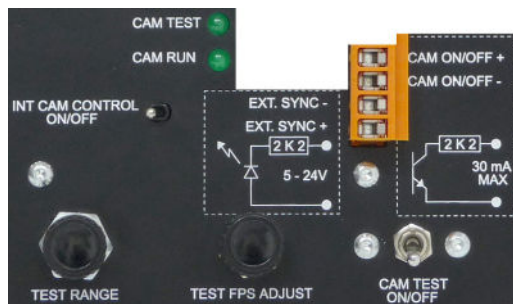

CAM TEST LED  - indicates that the internal simulated camera (Sync generator) in the Trigger Box is currently receiving an External Camera Trigger signal from Flair.

CAM RUN LED  - indicates that the internal simulated camera (Sync generator) in the Trigger Box is running. The light blinks in time with the Sync frequency.

INT CAM CONTROL ON/OFF - Controls how the internal simulated camera (Sync generator) is switched on and off:

- **On (CAM RUN LED is On or blinking)** - The internal simulated camera (Sync generator) is On. Trying to activate or deactivate it from Flair has no effect.
- **Off (CAM RUN LED is Off)** - Flair controls the on/off state of the internal simulated camera (Sync generator). That is, the simulated camera is off except when it is receiving an External Camera Trigger signal from Flair.

TEST RANGE - Coarse adjustment for the generated Sync signal frequency (Frames Per Second).

TEST FPS ADJUST - Fine adjustment for the generated Sync signal frequency (Frames Per Second).

CAM TEST ON/OFF - controls the routing of the Sync signal and External Camera Trigger signal.

- **Off** - The Trigger Box uses its external **CAM ON/OFF** and **EXT. SYNC** connectors. That is:
 - Flair receives the Sync signal that is coming from the real camera, via the **EXT. SYNC** connectors.
 - The External Camera Trigger output from Flair is sent to the real camera, via the **CAM ON/OFF** connectors.
- **On** - Camera testing mode. The Trigger Box uses its internal simulated camera (Sync generator) **instead of** the external **CAM ON/OFF** and **EXT. SYNC** connectors. That is:
 - Flair receives the Sync signal that is coming from the simulated camera (Sync generator) in the Trigger Box.
 - The External Camera trigger output from Flair is sent to the simulated camera in the Trigger Box, where it activates the Sync generator.

Testing the Sync signal input only

To test the Sync input, the Trigger Box can be plugged into any connector on the ribbon cable. To test Sync input and Camera On/Off trigger together, the Trigger Box must be plugged into the **SYNC** connector on the ribbon cable.

1. Turn on the internal simulated camera (Sync signal generator), by switching On the **INT CAM CONTROL ON/OFF** switch.
2. The **CAM RUN** LED () starts blinking. This might be slow or too fast to see, depending on the current Sync frequency. You can adjust the frequency by using the **TEST RANGE** and **TEST FPS ADJUST** knobs.
3. Switch On the **CAM TEST ON/OFF** switch. This routes the generated Sync signal to Flair.
4. In Flair, use menu option **Setups > External Camera Setup**.

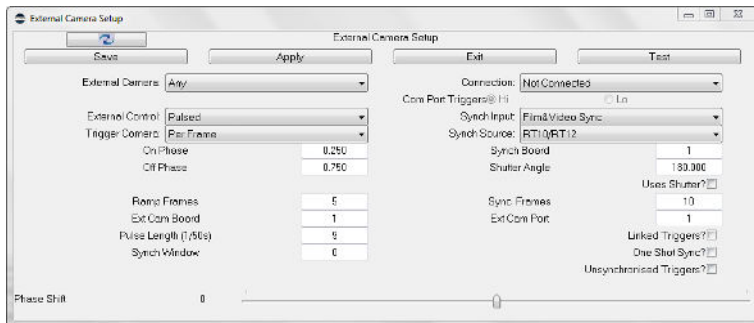

5. In the pop-up, specify the following settings:
External Camera: **Any**
Synch Input: **Film& Video Sync**
Synch Source: **RT12/RT14**
6. Click on **Save** and **Apply** in the pop-up, but leave the pop-up open on the screen.
7. In the pop-up, click on the **Test** button.

Flair analyses the incoming Sync signal and displays various parameters for it in a pop-up:

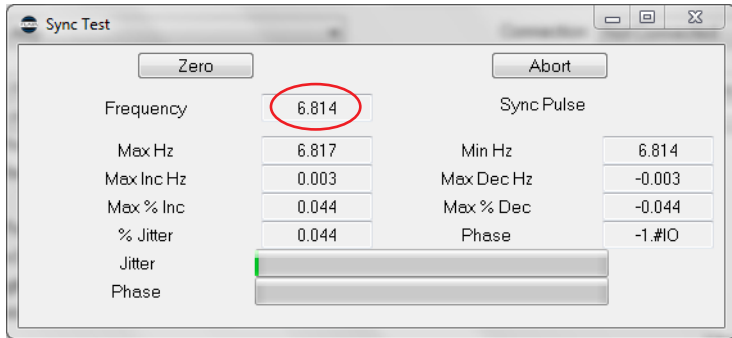

The Sync signal **Frequency** is displayed at the top. You can adjust it using the **TEST RANGE** and **TEST FPS ADJUST** knobs on the Trigger Box.

This completes the Sync input test. To test the External Camera trigger output, continue to the next section without closing any windows. If you are finished testing, refer to *Returning the Trigger Box to normal working mode* on page 17.

Testing the Sync signal input and External Camera trigger output together

To test Sync input and Camera On/Off trigger together, the Trigger Box must be plugged into the **SYNC** connector on the ribbon cable. Then perform these steps:

1. Follow the complete procedure for testing the Sync signal input in the previous section (*Testing the Sync signal input only* on page 14). When you get to the end of the procedure, leave all windows open.
2. Put the Sync signal generator under Flair control, by switching Off the **INT CAM CONTROL ON/OFF** switch (**CAM RUN LED** Off).
3. In Flair, in the External Camera Setup pop-up (**Setups > External Camera Setup**), change the External Control setting from **Pulsed** to **Continuous High**.

4. In Flair, use menu option **Setups > Outputs > Test Outputs.**
5. In the pop-up, click on the **Ext. Cam** button to trigger the simulated camera (Sync generator) in the Trigger Box.

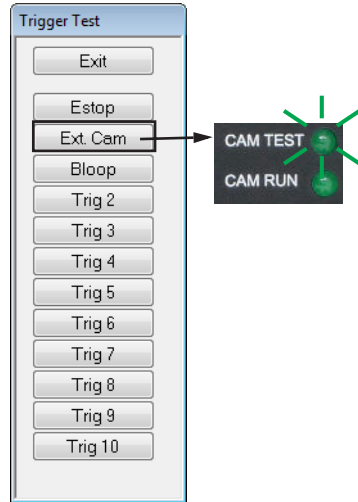

When you hold down the **Ext. Cam** button, several things should happen:

- The **CAM TEST** LED lights up, indicating that the Trigger Box has received the External Camera trigger output from Flair.
- The **CAM RUN** LED lights up indicating that the internal simulated camera (Sync generator) in the Trigger Box is running. This LED blinks in time with the Sync frequency. You can adjust it using the **TEST RANGE** and **TEST FPS ADJUST** knobs on the Trigger Box.
- The Sync Test pop-up in Flair updates the displayed **Frequency** data:

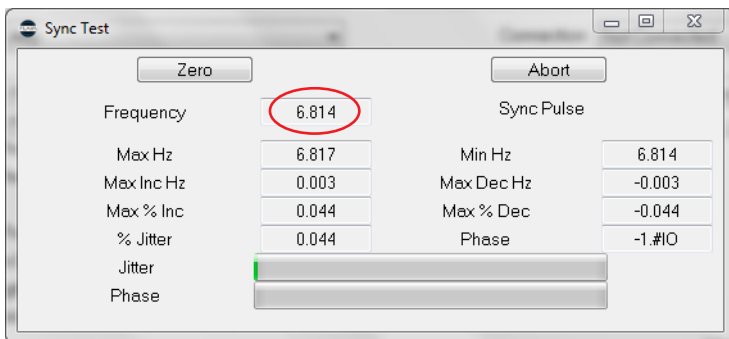

When you release the **Ext. Cam** button the **CAM TEST** and **CAM RUN** LEDs will go out and Flair will not detect a Sync signal.

This completes the test. Refer to the next section to return the Trigger Box to its normal working mode.

Returning the Trigger Box to normal working mode

1. Turn Off the internal simulated camera (Sync generator) by switching off the **INT CAM CONTROL ON/OFF (CAM RUN LED Off)**
2. Switch Off the **CAM TEST ON/OFF** switch so that the Trigger Box uses its external **CAM ON/OFF** and **EXT. SYNC** connectors again. Even if you are not using these connectors, setting this switch to Off prevents any accidentally generated Sync signal (from the Trigger Box) from interfering with the real Sync signal coming from the camera.
3. Plug the Trigger Box back into the ribbon cable connector that suits your requirements (see *Connecting the cables* on page 2).
4. In Flair, in the **Setups > External Camera Setup** pop-up, change the settings back to those appropriate for your camera.

Appendix 1 Troubleshooting

Typical symptoms, causes, and actions

Symptoms	Cause and/or action
<p>A trigger output fails to activate.</p> <p>The relevant OUT LED on the Trigger Box fails to light up.</p>	<p>Check all connections.</p> <p>Try to isolate the problem:</p> <ul style="list-style-type: none"> • In Flair, check that you have assigned the output trigger to the correct frame (menu option Setups > Outputs, page 5). • Make sure the Trigger Box is receiving the trigger signal from Flair, by checking that the relevant OUT LED on the Trigger Box lights up when the trigger is activated in Flair (page 6). • Make sure the device you are trying to trigger is plugged into the correct socket on the ribbon cable (page 2). The BLOOP socket does not receive the Camera Trigger output signal. The TRIGGER socket does not receive the External Camera Trigger or Trigger 1 output signals. • If it is practical and safe to do so, check that your external trigger circuitry and device are working by connecting the trigger wires to close the circuit.

Symptoms	Cause and/or action
<p>Flair fails to trigger the External Camera</p>	<p>See if you can trigger the camera manually, by using Flair menu option Setups > Outputs > Test Outputs (page 15).</p> <p>If the camera is connected to the CAM ON/OFF connectors on the Trigger Box, make sure the CAM TEST ON/OFF switch is in the correct position (page 13). The switch must be Off if you want Flair to trigger a real camera that is connected to the CAM ON/OFF connectors on the Trigger Box, and On if you want Flair to trigger the simulated camera (Sync generator) in the Trigger Box.</p> <p>If you are trying to trigger the simulated camera (Sync generator) in the Trigger Box from Flair, make sure the INT CAM CONTROL ON/OFF switch is Off so that the Sync generator is under Flair control.</p>
<p>A trigger input fails to activate</p> <p>Note: Trigger input 3 (IN 3) is not operational in the current version.</p>	<p>Check all connections.</p> <p>Try to isolate the problem:</p> <ul style="list-style-type: none"> • In Flair, check that you have assigned the incoming trigger to the action you want (Setups > Inputs setup, page 7). • Make sure Flair is receiving the trigger signal from the Trigger Box, by checking that the relevant Trigger Input State changes from Open to Closed in the Setups > Inputs setup pop-up in Flair when you press the relevant IN button on the Trigger Box (page 7). • Check that the external device is either closing the Trigger input circuit or supplying the correct trigger input voltage, depending on the method you are using to configure the trigger inputs (page 7).

Symptoms	Cause and/or action
Flair is not receiving a Sync signal from the Trigger Box.	<p>Make sure the CAM TEST ON/OFF switch is in the correct position (page 13). The switch must be Off if you want Flair to receive the signal from a real camera that is connected to the EXT. SYNC connectors on the Trigger Box, and On if you want Flair to receive the signal from the simulated camera (Sync signal generator) in the Trigger Box.</p> <p>If you testing Flair with the simulated camera (Sync signal generator), make sure the INT CAM CONTROL ON/OFF switch is in the correct position (page 13). If the switch is Off then the internal simulated camera (Sync generator) is under Flair control, and you will need to activate the Sync signal by activating the External Camera from Flair (Setups > Outputs > Test Outputs, page 15).</p>

Notes

Appendix 2 Trigger Box panels

Panel and connector summary

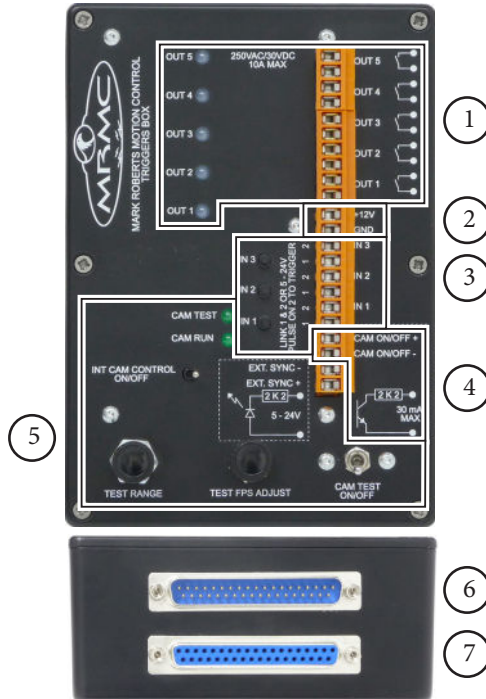

1. Five trigger outputs, numbered **OUT 1** to **OUT 5**, and their corresponding LED indicators. For details of usage see *Using the trigger outputs* on page 5.
2. **+12V** and **GND** DC power output connectors, for powering external devices.
3. Three trigger inputs, numbered **IN 1** to **IN 3**, and their corresponding testing buttons, for triggering events in Flair software such as starting a pre-recorded move. For details of usage see *Using the trigger inputs* on page 7.

4. **CAM ON/OFF +, CAM ON/OFF -** connectors, used for triggering a camera on and off. In Flair you have a choice of the type of signal used, to fit the requirements of the camera. For details of usage see *Using the Camera On/Off trigger output* on page 8.
5. Controls for testing Flair's handling of the Sync input and External Camera trigger output signals. For details of usage see:
Using the Sync input from a camera on page 10
Testing the Sync input and Camera On/Off trigger output on page 12.
6. Triggers connector, for connecting the Trigger Box to an RT-14 or RT-14 unit. The RT-14 unit is, in turn, connected to a PC running Flair Motion Control Software. For pin-out information see *Triggers connector* on page 24.
7. Additional connector, for adding another Trigger Box or more trigger devices to the daisy-chain. For pin-out information see *Triggers connector* on page 24.

Connector pin-out information

Triggers connector

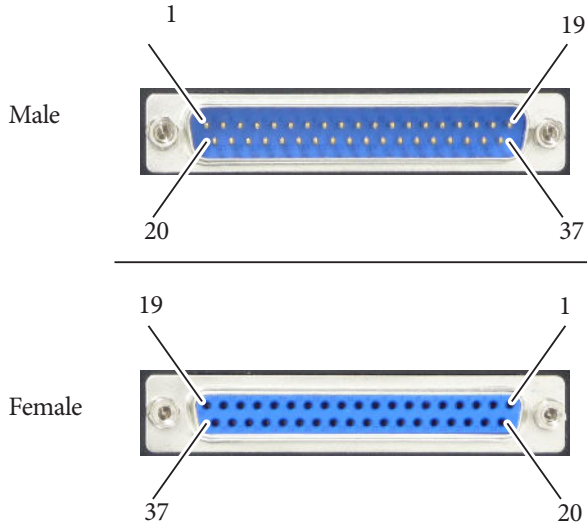

The male and female trigger connectors used on the Trigger Box and its ribbon cable are 37-way D-type that have the same pin assignments:

1. OUT1+ (Reserved: Camera control)
2. OUT2+ (Trigger 1 Out +)
3. OUT3+ (Trigger 2 Out +)
4. OUT4+ (Trigger 3 Out +)
5. OUT5+ (Trigger 4 Out +)
6. OUT6+ (Trigger 5 Out +)
7. OUT7+ (Trigger 6 Out +)
8. OUT8+ (Trigger 7 Out +)
9. OUT9+ (Trigger 8 Out +)
10. OUT10+ (Trigger 9 Out +)
11. OUT11+ (Trigger 10 Out +)
12. 0V
13. IN1+ (Reserved: Sync Input)
14. IN2+ (Trigger 1 In +)
15. IN3+ (Trigger 2 In +)
16. IN4+ (Trigger 3 In +: not used)
17. IN5+ (Not used)

18. IN6+ (Not used)
19. +12V
20. OUT1- (Reserved: Camera control)
21. OUT2- (Trigger 1 Out -)
22. OUT3- (Trigger 2 Out -)
23. OUT4- (Trigger 3 Out -)
24. OUT5- (Trigger 4 Out -)
25. OUT6- (Trigger 5 Out -)
26. OUT7- (Trigger 6 Out -)
27. OUT8- (Trigger 7 Out -)
28. OUT9- (Trigger 8 Out -)
29. OUT10- (Trigger 9 Out -)
30. OUT 11- (Trigger 10 Out -)
31. 0V
32. IN1- (Reserved: Sync Input)
33. IN2- (Trigger 1 In -)
34. IN3- (Trigger 2 In -)
35. IN4- (Trigger 3 In -: not used)
36. IN5- (Not used)
37. IN6- (Not used)

Appendix 3 Laser Switch

Connecting the Laser Switch



The laser switch can be used to start/stop a move or camera like any other input to Flair. It can be connected directly to the Trigger box in any of the input channels, as shown above.

The sensor will switch when the beam between the reflector is interrupted/restored.



Red LED indicates that sensor is powered.



Blue LED indicates the sensor is detecting the beam.

In Flair, the input will be shown in the Input Triggers Setup dialog box depending on which input it has been wired (the picture shows an example with the laser wired to Input 1).

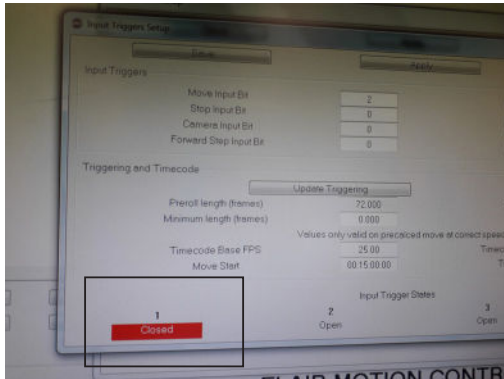

The corresponding input bit must be set in Flair to execute the desired action, like any other input. Refer to the Chapter on *Inputs, Outputs and DMX* of the Flair manual for more detail.

Notes

Appendix 4 Specifications

Weight: 0.7 Kg

Temperature range: 0-45 °C (32-113 °F)

Humidity tolerance: 0% to 85% relative humidity, non-condensing

Dimensions: All measurements are in mm:

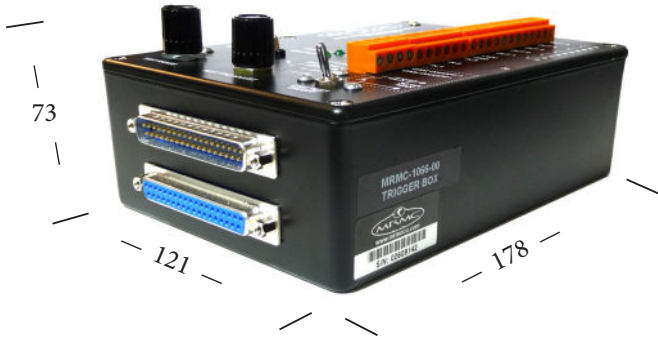

Power I/O

Input: 250VAC

Output: 30VDC 10A max, if load is highly inductive limit the output to 3A

Circuit diagram

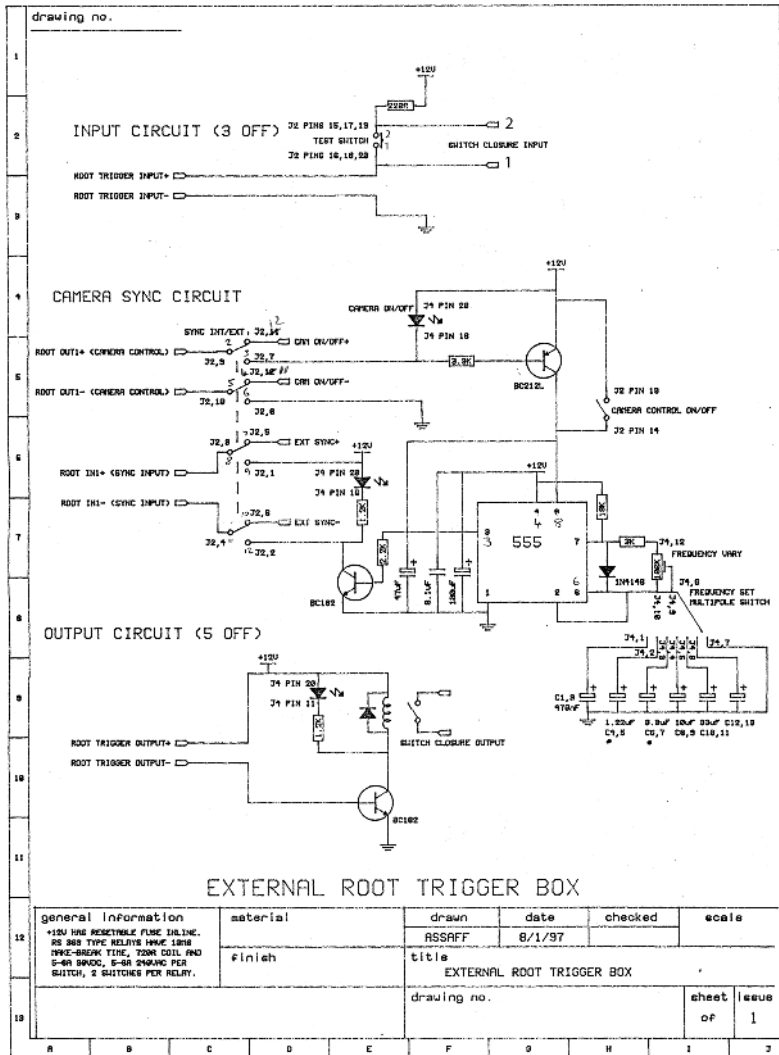

Notes



Mark Roberts Motion Control Ltd.

Unit 3, South East Studios, Blindley Heath, Surrey RH7 6JP

United Kingdom

Telephone: +44 (0) 1342 838000

info@mrmoco.com

www.mrmoco.com

