



Mark Roberts Motion Control
LEADERS IN CAMERA ROBOTICS

RT-14



QUICK START GUIDE

Part number: MRMC-1473-00

Product code: MRMC-1188-02

RT-14 Quick Start Guide

Part number: MRMC-1473-00

Product code: MRMC-1188-02

© 2017 Mark Roberts Motion Control Ltd. All rights reserved.

No part of this publication may be reproduced, transmitted, or translated by any means — graphical, electronic, or mechanical — including photocopying, recording, taping, or storage in an information retrieval system, without the express written permission of Mark Roberts Motion Control.

Although every care has been taken to ensure that the information in this document is accurate and up to date, Mark Roberts Motion Control continuously strives to improve their products and may make changes to the hardware, firmware, and software described in this document. Mark Roberts Motion Control therefore cannot be held responsible for any error or omission in this document.

All product names mentioned herein are the trademarks or registered trademarks of their respective owners.

Contact information	
Mark Roberts Motion Control Ltd.	
Unit 3, South East Studios	
Blindley Heath	
Surrey	
RH7 6JP	
United Kingdom	
Telephone:	+44 (0) 1342 838000
E-mail:	info@mrmoco.com (sales and general enquiries) support@mrmoco.com (customer support)
Web:	www.mrmoco.com www.mrmocorentals.com

Contents

Chapter 1	Quick start	1
	Important safety instructions	1
	Power and connections	1
	General care	1
	Location	2
	Intellectual property	2
	Overview	2
	Connecting the cables	3
	Example of a rig connected using the RT-14	4
Appendix 1	Troubleshooting	8
	Typical symptoms, causes, and actions	8
	Managing LAN addresses with Flair	9
Appendix 2	Front panel.....	13
	Panel summary	13
	LEDs	13
	Switch	14
Appendix 3	Rear panel	15
	Panel and connector summary.....	15
	Connector pin-out information.....	17
	Serial Out connector	17
	HHB connector.....	17
	MIMIC 1 connector	18
	MIMIC 2 connector	19
	Video In connector.....	20
	Rig/Heads connector.....	20
	Triggers connector.....	21
	LTC In connector.....	22
	LTC Out connector.....	22
	E-Stop bolt connector	22
	E-Stop connector	23
	24V In connector	23

Appendix 4	Specifications.....	24
	I/O Formats	24
	25
	Mimic inputs.....	25
	E-stop for Bolt.....	26

Chapter 1 Quick start



Important safety instructions

To ensure the best from the product, please read this manual carefully. Keep it in the safe place for future reference.

To reduce the risk of electric shock, do not remove the cover from the unit. No user serviceable parts inside. Refer servicing to qualified personnel.

Power and connections

- This unit must be connected to a mains socket outlet with a protective earth connection.
- This unit is not disconnected from the AC power source as long as it is connected to the wall outlet.
- When not using the unit for a long period of time, ensure that the AC power cord is disconnected from the wall outlet.
- The AC wall outlet should be installed near to the unit and be easily accessible.
- Do not plug in or attempt to operate an obviously damaged unit.

General care

- Do not force switches or external connections.
- When moving the unit, disconnect the mains cable and then disconnect the long umbilical cable.
- Do not attempt to clean the unit with chemical solvents or aerosol cleaners, as this may damage the unit. Use a clean dry cloth.
- Do not use around flammable gas. All electrical equipment can generate sparks that can ignite flammable gas.
- Keep the equipment dry. The system has **not** been made weatherproof. Do not use with wet hands.

- Keep away from pets and children. The head has powerful motors that can pinch, so take care not to get your hands trapped in the head or cabling.
- Keep cables tidy. Use cable ties to keep them out of harm's way. If you have a head with slip rings then make use of them; avoid running any cables between the base and the rotating head or camera.

Location

Installation of this unit should be away from sources of excessive heat, vibration, and dust.

Intellectual property

This product includes confidential and/or trade secret property. Therefore, you may not copy, modify, adapt, translate, distribute, reverse engineer, or decompile contents thereof.

Overview

Thank you for using the RT-14 from Mark Roberts Motion Control (MRMC). The RT-14 is an Ethernet controlled interface unit between Flair Motion Control Software and MRMC Motion Control and Broadcast rigs.

Connecting the cables

The minimum configuration is 24V power and Ethernet connected to a PC or laptop. The RT-14 has its own IP address and a successful connection can be seen in Flair motion control software. You can then attach the devices that are needed to complete the particular rig configuration desired. The following is a basic setup using the RT-14.

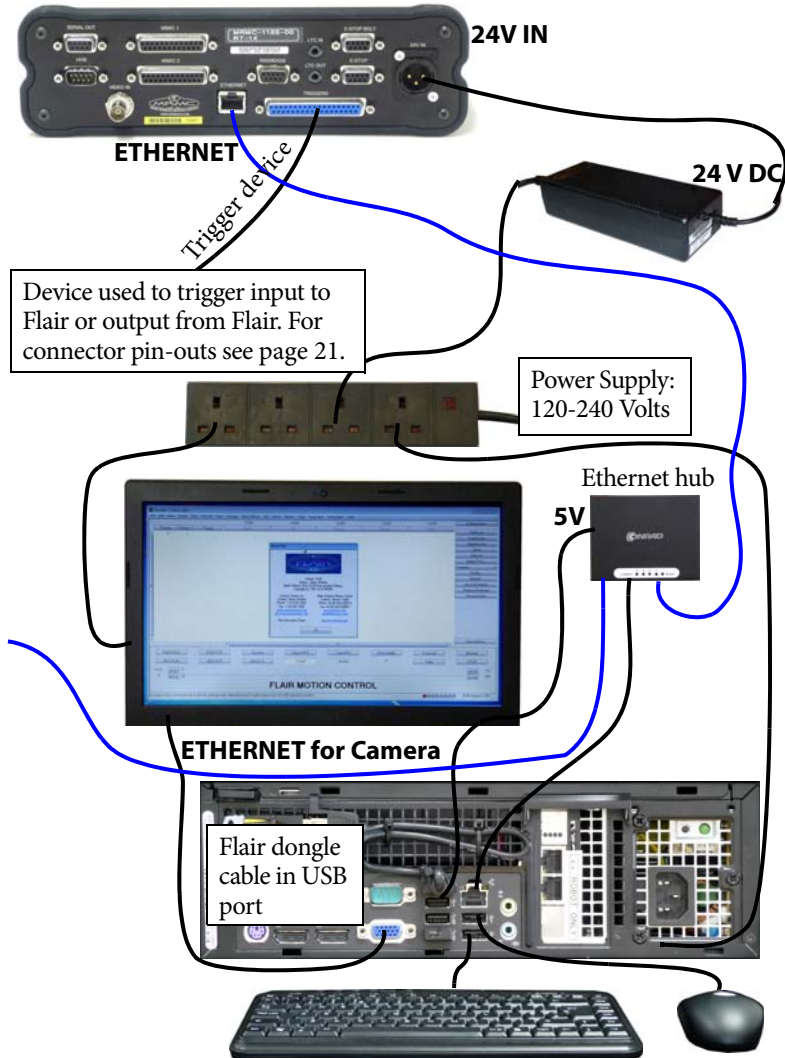

Example of a rig connected using the RT-14

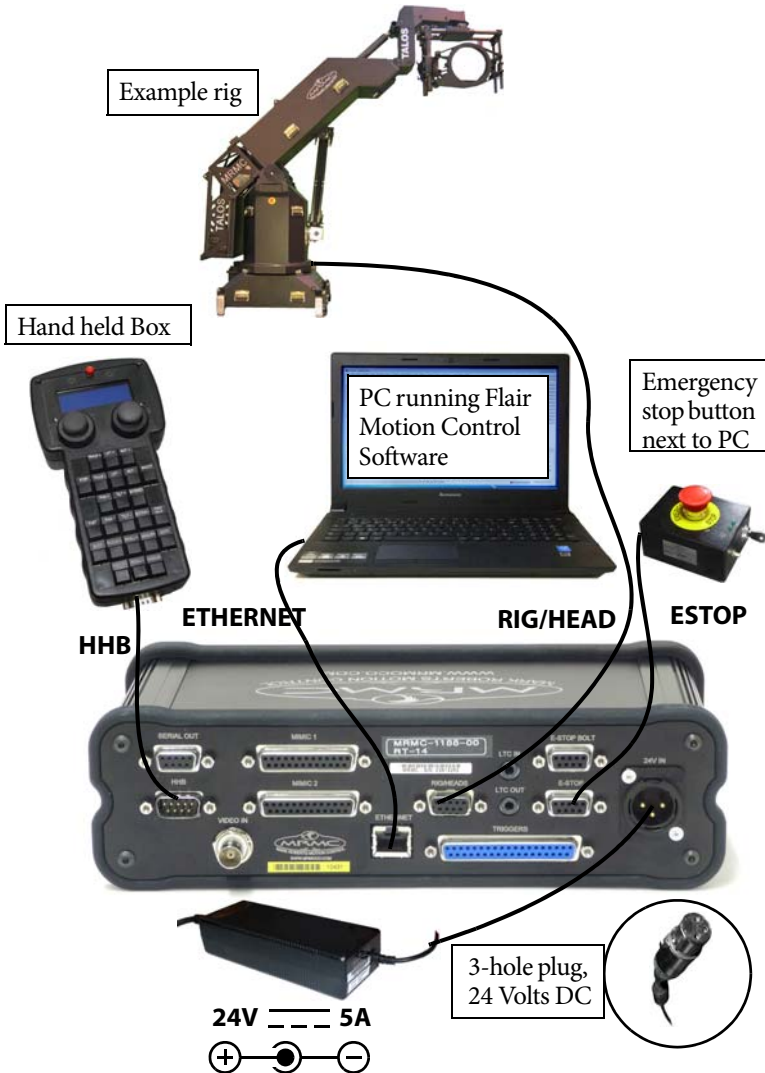

The RT-14 has the following main features:

- Provides Data Link output, for example, to larger or legacy-type rigs
- Provides Serial output

- Provides Hand Held box, or HHB, interface
- Provides E-Stop interface for BOLT and other rigs
- Provides MIMIC inputs and outputs for Pan bars, Focus and Zoom controllers
- Sends and receives Linear Timecode (LTC)
- Provides an interface to input and output triggers
- Provides BNC video input for syncing FLAIR via internal sync generator

Notes

Notes

Appendix 1 Troubleshooting

Typical symptoms, causes, and actions

Symptoms	Cause and/or action
The head connected to the RT-14 did not power up.	Power up the RT-14 and check the POWER and INHIBIT LEDs illuminate
Flair cannot connect to the RT-14 and  appears at the bottom-right corner in the Flair window.	<p>Check the IP address of the RT-14 ends with .234.</p> <p>Ensure that the PC running the Flair motion control software and the RT-14 are on the same network.</p> <p>For more help on IP addresses, see <i>Managing LAN addresses with Flair</i> on page 9.</p>

Managing LAN addresses with Flair

The factory-set IP address of the RT-14 is 192.168.1.234.

If the IP address of the RT-14 has been changed to an unknown value so you can't load the RT-14, you can find out the RT-14's IP address by connecting the RT-14 to a Windows PC that has Flair Motion Control Software installed on it and using Flair to interrogate the RT-14 on the network.

The procedure below tells you how to use Flair to find the IP address of the RT-14, and if necessary change it. You can also use Flair to change the IP, SN, and GW addresses of the RT-14 if necessary.

1. Find a PC that has Flair Motion Control Software installed on it, or install Flair on your own PC.
2. Attach the RT-14 to the PC with an Ethernet cable.
3. Make sure the RT-14 has power, by checking that the power indicator LED on the head lights up.
4. Start Flair on the PC.
5. If you get any error messages, click on **OK** to close them.
6. When you get a message about network failure, click on the **Network Setup** button in the message:



Power
LED

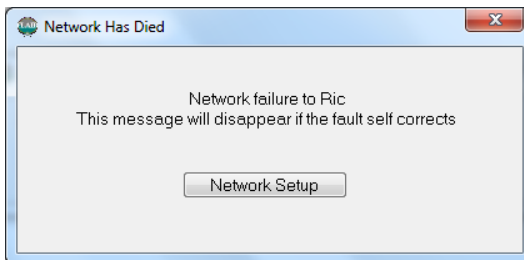

or...

If the Flair installation already has a valid RT-14 connection on a network then you might not get the network failure message. In this case, start the Network Setup facility manually by choosing the **Setups > Network Setup** menu option in Flair.



The Network Setup window, Connection tab, lists the Nodes (board and head connections) that Flair is looking for, as defined in the NetworkDirect.ini file. Any changes that you make and **Save** in the Network Setup window are saved in the NetworkDirect.ini file. You can also edit this file by using the menu option **Help > View Network.ini File**. If Flair cannot find the RT-14 on the network at the IP address shown then the node's status is **Not connected**.

7. In the Network Setup window click on **Find**, then on **OK** in the pop-up to confirm:

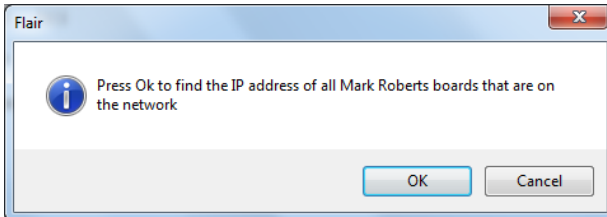

8. An Information pop-up displays information about the heads that Flair has found on the network:

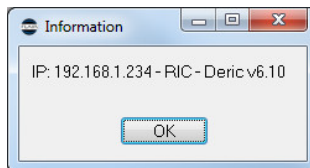

Make a note of the RT-14's IP address that is displayed in the pop-up; for example 192.168.1.234.

9. You can use Flair to change the IP address stored in the RT-14, or to inspect or change the SN or GW addresses. To do this:

- 9.1 Enter the RT-14's existing IP address (as shown in the Information pop-up) into the Network Setup window and click on **Save**.

- 9.2 Click on **Load** to reset and load the RT-14.

Once Flair is connected to the head, any LAN address changes that you make and **Save** in the Network Setup window will also affect the LAN addresses stored in the head.

- 9.3 To change the IP address of the RT-14, enter the new IP address into the Network Setup window now and click on **Save**.

The Status temporarily changes to **Not connected** as Flair changes the IP address in the RT-14, then to **Connected** as Flair reconnects with the RT-14 at its new IP address.

- 9.4 To inspect or change the SN or GW address of the RT-14, click on **Find** again. A pop-up shows the head's three current LAN addresses, and the **Subnet Mask** (SN) and **Default Gateway** (GW) fields in the Network Setup window become editable. Enter the new SN and GW addresses that you want to use and click on **Save**.

10. Close the Network Setup window by clicking on **Exit**.

Notes

Appendix 2 Front panel

Panel summary



LEDs

1. **POWER LED:**

- Off: Root Interface Card not powered.
- On: Root Interface Card has 3.3V.

2. **RUNNING LED:**

- Off: Root Interface Card not running.
- Flashing 25Hz: Root Interface Card loaded and running.
- Flashing 3Hz, 1/3 On, 2/3 Off: Failed to load first board on Rig/Head connection.

3. **INHIBIT LED:**

- Off: Flair is running.
- On: Flair is not running.

4. **RESET LED:**

- Off: Hardware not in reset.
- On: Hardware is currently being reset.

Switch

5. **POWER:**

- Top Out: RT-14 off
- Top In: RT-14 on.

Appendix 3 Rear panel

Panel and connector summary

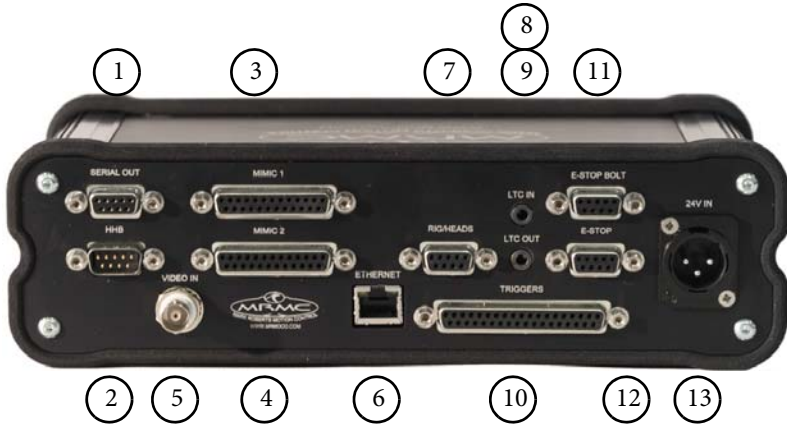

1. **SERIAL OUT** connector is connected to the rig or head that are loaded and run over SERIAL. For pin-out information see *Serial Out connector* on page 17.
2. **HHB** connector to the D-type connector on the Hand Held box marked HHB. The Hand Held Box (HHB) allows the user to remotely move the camera, for example to the exact desired position for setting up a move. For pin-out information see *HHB connector* on page 17.
- 3, 4. **MIMIC 1** and **MIMIC 2** connectors are used if different controllers such as Pan bars, Focus, and Zoom controllers are being used in the system. Flair motion control software must then be configured to accept the correct controller on the correct MIMIC input. For pin-out information see *MIMIC 1 connector* on page 18 and *MIMIC 2 connector* on page 19.
5. **VIDEO IN** connector for synchronisation signal from the camera. The RT-14 accepts an external video source, which is decoded to provide a frame sync pulse which is sent to Flair for it to match the camera video frame rate and phase. This uses a standard coaxial cable. For pin-out information see *Video In connector* on page 20.

6. **ETHERNET** RJ45 connector, for connection to the PC running the Flair Motion Control software. The Ethernet port is rated at 100Mbps/sec but can operate at lower speeds of 10 Mbps/sec or less.
7. **RIG/HEADS** connector is connected to the **DATA IN** connector on the rig or head and is used to provide the firmware transfer and to control the rig or head using Flair motion control software. For pin-out information see *Rig/Heads connector* on page 20.
8. **LTC IN** and **LTC OUT** connectors are used to connect to other equipment in the setup that can be synchronized with Flair using a time code. Flair can be synchronised to an externally produced time code or vice versa. For pin-out information see *LTC In connector* on page 22 and *LTC Out connector* on page 22.
10. **TRIGGERS** connector, for connecting the RT-14 to provide some inputs and outputs. For example, you might need to start and stop another machine, light other equipment using a voltage signal as triggered by Flair. Reversely, Flair may need to be started and stopped by an external source providing a changing voltage signal. For pin-out information see *Triggers connector* on page 21.
11. **E-STOP BOLT** connector for connecting to the Emergency Stop for Bolt. For pin-out information see *E-Stop bolt connector* on page 22.
12. **E-STOP** connector for connecting to the Emergency Stop. The Emergency stop or E-Stop is a necessary safety feature fitted to almost all motion control equipment. The E-Stop button is placed close to the operator and pressed when the rig is required to be stopped immediately. For pin-out information see *E-Stop connector* on page 23.

Note

If the system is a Bolt, connect the cable on the Emergency Stop to the **E-STOP BOLT** connector on the RT-14.

13. **24V IN** connector. The RT-14 requires a 3-pin, 24 Volt DC power supply. For pin-out information see *24V In connector* on page 23.

Connector pin-out information

Serial Out connector

Serial Out is a (9-way D-type Female) connector can be used for connecting any head that uses Ulti-box.

1. N/C
2. N/C
3. RX
4. TX
5. N/C
6. GND
7. N/C
8. N/C
9. N/C
10. N/C

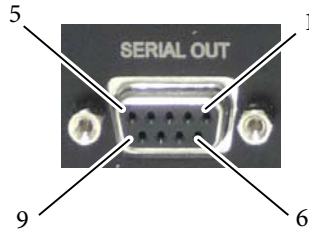

HHB connector

HHB is a (9-way D-type Male) connector used for connecting the Hand Held box to the RT-14.

1. +12V
2. RX
3. TX
4. N/C
5. GND
6. N/C
7. E-Stop
8. E-Stop
9. N/C

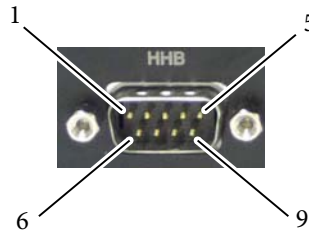

MIMIC 1 connector

MIMIC 1 is a (25-way D-type Female) connector.

1. A1+
2. B1+
3. A2+
4. B2+
5. A3+
6. B3+
7. A4+
8. B4+
9. Mimic GPO 1 (Open collector) LED
10. Mimic GPO 2 (Open collector) LED
11. Mimic GPO 3 (Open collector) LED
12. Mimic GPO 4 (Open collector) LED
13. +12V
14. A1-
15. B1-
16. A2-
17. B2-
18. A3-
19. B3-
20. A4-
21. B4-
22. +5V
23. GND
24. GND
25. GND

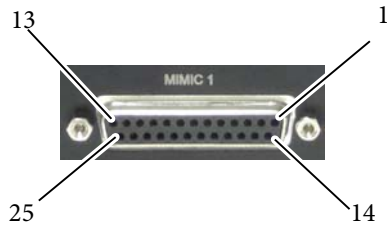

MIMIC 2 connector

MIMIC 2 is a (25-way D-type Female).

1. A5+
2. B5+
3. A6+
4. B6+
5. A7+
6. B7+
7. A8+
8. B8+
9. Mimic GPO 5 (Open collector) LED
10. Mimic GPO 6 (Open collector) LED
11. Mimic GPO 7 (Open collector) LED
12. Mimic GPO 8 (Open collector) LED
13. +12V
14. A5-
15. B5-
16. A6-
17. B6-
18. A7-
19. B7-
20. A8-
21. B8-
22. +5V
23. GND
24. GND
25. GND

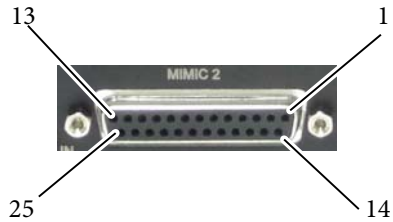

Video In connector

Video In is a (BNC Female) connector used for connecting a Tri-level/ Bi-level video sync signal to the RT-14. The RT-14 can synchronize on the incoming analogue video signal through this port.

1. Video In (HD or SD)
(Center)
2. GND

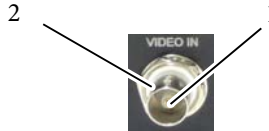

Rig/Heads connector

Rigs/Heads is a (9-way D-type Female) connector used for connecting the rig or head to the RT-14.

1. Watchdog-
2. Data Out-
3. Data In-
4. E-Stop+
5. N/C
6. Watchdog+
7. Data Out+
8. Data In+
9. E-Stop-

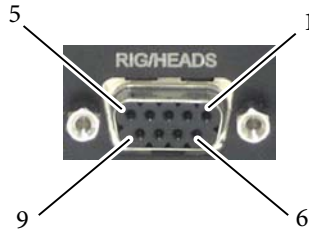

Triggers connector

The Triggers connector is a (37-way D-type Female) used to connect any trigger device with the RT-14 and its ribbon cables are 37-way D-type that have the same pin assignments:

1. OUT1+ (Reserved: Camera start/stop control)
2. OUT2+ (Trigger 1 Out +)
3. OUT3+ (Trigger 2 Out +)
4. OUT4+ (Trigger 3 Out +)
5. OUT5+ (Trigger 4 Out +)
6. OUT6+ (Trigger 5 Out +)
7. OUT7+ (Trigger 6 Out +)
8. OUT8+ (Trigger 7 Out +)
9. OUT9+ (Trigger 8 Out +)
10. OUT10+ (Trigger 9 Out +)
11. OUT11+ (Trigger 10 Out +)
12. 0V
13. IN1+ (Reserved: Sync Input)
14. IN2+ (Trigger 1 In +)
15. IN3+ (Trigger 2 In +)
16. IN4+ (Trigger 3 In +)
17. IN5+ (Not used)
18. IN6+ (Not used)
19. +12V
20. OUT1- (Reserved: Camera start/stop control)
21. OUT2- (Trigger 1 Out -)
22. OUT3- (Trigger 2 Out -)
23. OUT4- (Trigger 3 Out -)
24. OUT5- (Trigger 4 Out -)
25. OUT6- (Trigger 5 Out -)
26. OUT7- (Trigger 6 Out -)
27. OUT8- (Trigger 7 Out -)
28. OUT9- (Trigger 8 Out -)
29. OUT10- (Trigger 9 Out -)
30. OUT 11- (Trigger 10 Out -)
31. 0V
32. IN1- (Reserved: Sync Input)
33. IN2- (Trigger 1 In -)
34. IN3- (Trigger 2 In -)
35. IN4- (Trigger 3 In -)
36. IN5- (Not used)



37. IN6- (Not used)

LTC In connector

LTC In is a (3.5 mm Stereo Female Jack) connector used for connecting time-code to the RT-14.

1. N/C
2. LTC In Tip Ring
3. Sleeve



LTC Out connector

LTC Out is a (3.5 mm Stereo Female Jack) connector used for connecting time code generated by the RT-14.

1. N/C
2. LTC Out Tip Ring
3. Sleeve



E-Stop bolt connector

E-Stop Bolt is a (9-way D-type Female) connector used for connecting the emergency stop for Bolt to the RT-14.

1. Rig E-Stop 2
2. Rig E-Stop 3
3. N/C
4. Rig E-Stop 3
5. Rig E-Stop 2
6. N/C
7. N/C
8. N/C
9. N/C

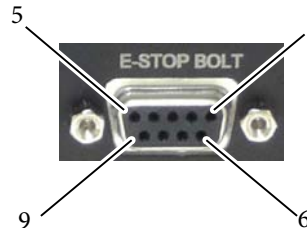

E-Stop connector

E-Stop is a (9-way D-type Female) connector used for connecting the emergency stop to the RT-14.

1. Rig E-Stop
2. +12V
3. Override switch
4. GND
5. Rig E-Stop
6. Model Mover E-stop
7. N/C
8. N/C
9. Model Mover E-Stop

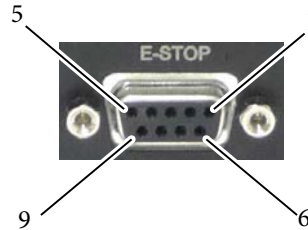

24V In connector

24V In is a (3-pin XLR Male) connector to supply power to the RT-14. The RT-14 can run from 12-35 Volts DC.

1. GND
2. +24V
3. N/C

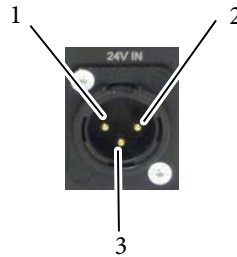

Appendix 4 Specifications

Weight: 1.1 Kg

Temperature range: 0-45 °C (32-113 °F)

Humidity tolerance: 0% to 85% relative humidity, non-condensing

Dimensions: All measurements are in mm:

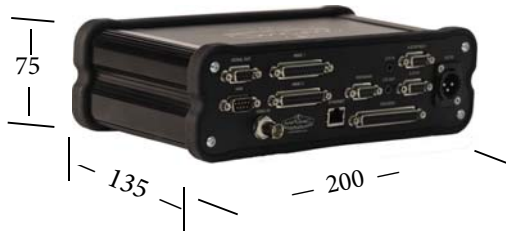

I/O Formats

The following figure shows the typical applications of the RT-14.

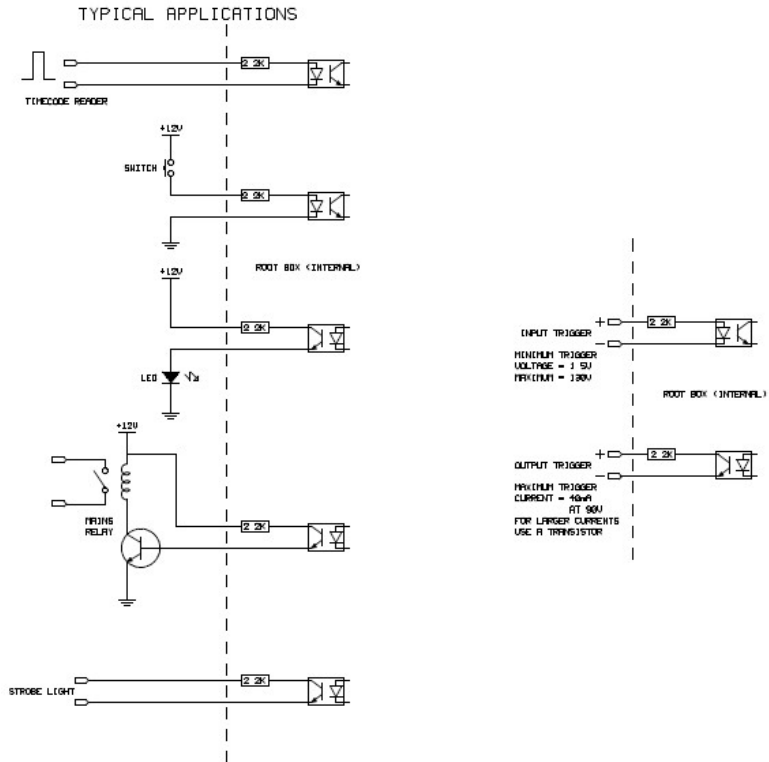

Mimic inputs

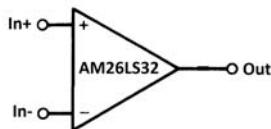

E-stop for Bolt

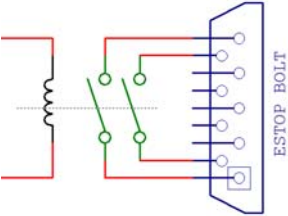

Notes



Mark Roberts Motion Control Ltd.

Unit 3, South East Studios, Blindley Heath, Surrey RH7 6JP

United Kingdom

Telephone: +44 (0) 1342 838000

info@mrmoco.com

www.mrmoco.com

